

Turbine Meter TRZ 03



PRODUCT INFORMATION

Reliable Measurement of Gas



TURBINE METER TRZ 03

Method of operation, Construction

Method of operation

The TRZ 03 turbine meter is a flow meter suitable for gas measurement in compliance with EN 12261 and OIML, where the rate of flow is indicated by a mechanical totalizer in units of volume (cubic meters at flowing conditions) under prevailing pressure and temperature. The gas flow is constricted to a definite cross section and drives a coaxially mounted turbine wheel. The speed of the turbine wheel, which is proportional to the flow rate, is reduced by gearing and transmitted to the mechanical digital index.

Construction

The meter case comprises the measuring element with the turbine wheel. A flow straightener located upstream of the measuring element substantially eliminates turbulences and swirl from the gas flow and directs the gas onto the turbine blades.

The rotary motion generated by the turbine wheel is transmitted by a magnetic coupling from the pressurized meter case to the unpressurized meter head.

The number of rotations is reduced by gearing in the meter head, which can be adjusted by selecting an appropriate pair of adjusting gears, so that cubic meters at flowing

conditions are indicated by the mechanical totalizer. A reed contact (or an inductive sensor) located on the mechanical totalizer provides low-frequency pulses whose number is proportional to the volume at actual conditions flowed through.

Inductive high-frequency sensors scan the turbine wheel (HF 3) and the reference wheel (HF 2). The latter is a cam wheel located on the same shaft as the turbine wheel which enables the turbine wheel to be monitored.

Furthermore, the meter head can be equipped with an encoder for digital transmission of the totalizer reading (V_0) to a volume corrector.

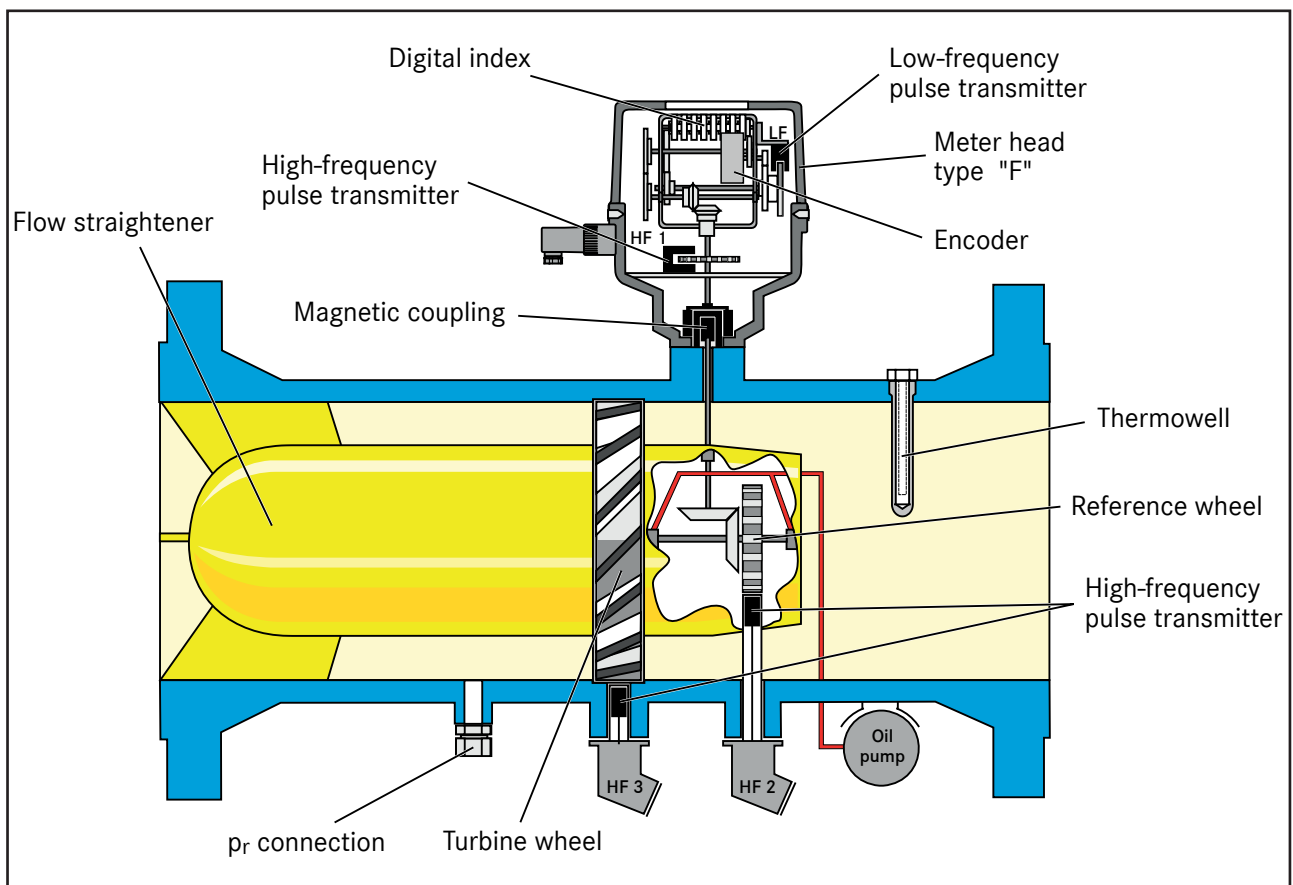

Features

LF-Pulse transmitter (in the meter head)

- Standard: reed contact
- Alternatively : inductive pulse transmitter
- Option: up to 3 LF pulse transmitters possible

HF-pulse transmitter (option)

- In the meter head: Inductive pulse transmitter (HF 1), pulse frequency at Q_{max} approx. 100 Hz.
- In the meter case: Inductive pulse transmitter for scanning
 - the blades of the turbine wheel (HF 3, from DN 80)
 - the cams of the reference wheel (HF 2, from DN 100)

All inductive pulse transmitters provide volume pulses in compliance with NAMUR.

Meter head (type "F")

- Protection class IP 65
- Universally readable
- Totalizer unit and HF1 pulse transmitter are easily replaceable on site.
- built in encoder of type ENCO 08 (option); no battery required.

Thermowell(s) inside the meter case (option)

To accommodate a resistance thermometer each.

Standard measuring range 1:20 (MID)

With high-pressure testing, measuring ranges up to 1:160 are possible (depending on operating pressure).

Nominal size: DN 50 through DN 600

Pressure rating: PN 10 through PN 100, ANSI 150 through ANSI 600

Operating temperature ranges:

- acc. to MID: -25°C to +55°C
- acc. to PED: -20°C to +80°C (spheroidal cast iron)
- 40°C to +80°C (cast steel)
- acc. to ATEX: -25°C to +70°C

Explosion protection

The pulse transmitters are intrinsically safe; their type of protection is Ex ib IIC T6. Therefore, the TRZ 03 can be operated in Zone 1.

Long service life

p_r-connection

To connect the pressure transmitter of a PTZ corrector.

Inspection report

In compliance with EN 10204/3.1, for strength and leak testing.



Materials

Rotor:

Delrin for DN 50 to DN 200 and PN 10 / PN 16.
 Aluminium alloy for all other diameters and pressure ratings and for meters with HF sensors.
 Aluminium rotors instead of delrin rotors on special request.

Meter case material (standard)

DN	PN				ANSI		
	10	16	25	40	150	300	600
50	Cast steel	Spheroidal cast iron	Cast steel	Cast steel	Cast steel	Cast steel	Cast steel
80	Cast steel	Spheroidal cast iron	Cast steel	Cast steel	Cast steel	Cast steel	Cast steel
100	Cast steel	Spheroidal cast iron	Cast steel	Cast steel	Cast steel	Cast steel	Cast steel
150	Cast steel	Spheroidal cast iron	Cast steel	Cast steel	Cast steel	Cast steel	Cast steel
200	Cast steel	Spheroidal cast iron	Cast steel	Cast steel	Cast steel	Cast steel	Cast steel
250	Cast steel	Cast steel	Cast steel	Cast steel	Cast steel	Cast steel	Cast steel
300	Cast steel	Cast steel	Cast steel	Cast steel	Cast steel	Cast steel	Cast steel
400	Cast steel	Cast steel	Cast steel	Cast steel	Cast steel	Cast steel	Cast steel
500	Cast steel	Cast steel	Cast steel	Cast steel	Cast steel	Cast steel	Cast steel
600	Cast steel	Cast steel	Cast steel	Cast steel	Cast steel	Cast steel	Cast steel

Spheroidal cast iron  Cast steel 
 Steel, welded 

TURBINE METER TRZ 03

Accuracy, Approval, Pressure loss

Accuracy

Error limits (standard):

±1.0% for Q_{\min} to 0.2 Q_{\max}

±0.5% for 0.2 Q_{\max} to Q_{\max}

These limits (half calibration error limits) apply in the event of a steady, swirl-free flow for an operating pressure above 4 bar and measuring range 1:20. Below 4 bar, the calibration error limit is reached.

Higher accuracy available on special request.

Repeatability: ±0.1%

All gas meters are tested in the factory with air under atmospheric pressure.

Approvals

The TRZ 03 turbine meter has been approved for custody transfer flow measurement. The reference number for approval is as follows:

MID approval: T10417

The TRZ 03 is also approved for high pressure applications with pressure ratings up to ANSI 600:

PED approval: CE0091

Pressure loss

The pressure loss Δp stated in the table applies to natural gas at Q_{\max} and 1 bar. From this, the pressure loss at actual conditions can be calculated using the following formula:

$$\Delta p_A = \Delta p \cdot \frac{\rho_N}{0.83} \cdot p_A \cdot \left(\frac{Q_A}{Q_{\max}} \right)^2$$

Δp_A = Pressure loss at actual conditions (p_A , Q_A) in mbar

Δp = Pressure loss at Q_{\max} with natural gas at 1 bar in mbar (see table)

ρ_N = Standard density of the gas in kg/m³

p_A = Operating pressure in bar (absolute)

Q_A = Flow rate at actual conditions in m³/h

Q_{\max} = Maximum flow rate in m³/h (see table)

Example:

Air, $\rho_N=1.29$ kg/m³, nominal meter size DN 100,

$Q_{\max}=400$ m³/h, $p_A=1.1$ bar(a), $Q_A=250$ m³/h.

Take from the table: $\Delta p=4$ mbar.

Hence:

$$\Delta p_A = 4 \cdot \frac{1.29}{0.83} \cdot 1.1 \cdot \left(\frac{250}{400} \right)^2 \text{ mbar} = 2.7 \text{ mbar}$$

Nominal size DN		Max. flow rate Q_{\max}	V_{LF}^*	Δp	HF-pulse transmitter (option)	
mm	in.	m ³ /h	m ³	mbar	HF2	HF3
50	2"	100	0.1	5	-	-
80	3"	160	1	2	-	•
		250	1	6		
		400	1	14		
100	4"	250	1	2	•	•
		400	1	4		
		650	1	10		
150	6"	650	1	2	•	•
		1000	1	6		
		1600	10	12		
200	8"	1600	10	3	•	•
		2500	10	8		
250	10"	1600	10	2	•	•
		2500	10	3		
		4000	10	7		
300	12"	4000	10	4	•	•
		6500	10	9		
		6500**	10	12		
400	16"	6500	10	3	•	•
		10000	10	8		
		10000**	10	11		
500	20"	10000	10	4	•	•
		16000	100	9		
600	24"	16000	100	4	•	•
		25000	100	9		

* V_{LF} : volume at actual conditions per LF-pulse

** : G 4000-45 / G 6500-45

- not available

• available for all pressure classes

Types of gas

The TRZ 03 standard design is suitable for use with all gases in compliance with the DVGW code of practice G260. The materials used are appropriate for gases and fuel gases, such as natural gas, refinery gas, gaseous liquid gases and their mixtures, nitrogen, CO₂ (dry), air and all inert gases.

For aggressive gases (e.g. biogas, acid gas or ethylene), there are special designs available with PTFE lining, special material, special lubrication, etc.

Mounting and operating instruction

The TRZ 03 turbine meters can be operated in horizontal or vertical position up to the nominal size of DN 150. For DN 200 the mounting position must be specified in the order. From the nominal size of DN 250, they can only be installed in a horizontal position.

Special instructions for startup and operation:

Turbine meters are precise measuring instruments and must therefore be carefully handled during transport, storage and operation.

Do not fill any downstream pipelines or station sections via the turbine meter. This may result in excessive flow rates with resultant damage to the turbine wheel.

The gas meter has been designed for short-term overload operation at up to 1.2 times the value of Q_{max}. Such load conditions should be avoided, however, in order to protect the TRZ 03 from any unnecessarily high flow rates. The gas flow must be free of shocks or pulsations, foreign particles, dust or liquids. Otherwise it is recommended that filters and separators be installed.

No components affecting the gas flow are permitted directly upstream of the turbine meter (see DVGW guidelines and PTB guideline G 13).

In each case, an inlet pipe is required whose length as specified in the type approval may be shorter than that specified in the Technical Guideline G 13. The lengths of the inlet and outlet pipes must be at least 2 DN, while also a bend may be used as outlet pipe. If there is a heavy flow perturbation (e.g. due to a gas pressure controller) upstream of the inlet pipe, it is additionally necessary to use a perforated-plate straightener. There are perforated-plate straighteners available of the type RMG LP-35, the latter resulting in a pressure loss which is 2.5 times lower than that of a standardized flow straightener complying with ISO 5167.

LP-35 perforated-plate straightener

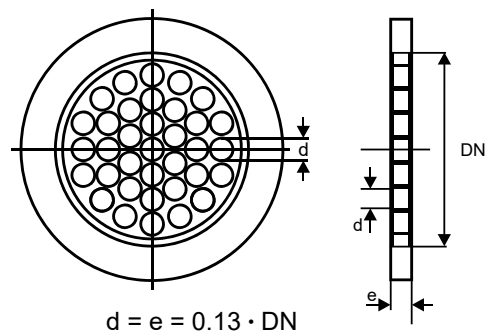

Reducers or expansion fittings must be installed upstream of the inlet pipe and their opening angle must not exceed 30°.

The gas meter must be installed in weatherproof locations. For outside installations, appropriate guards must be provided against direct weathering influences.

Maintenance

All turbine meters are fitted with a lubricator (DN 50 through DN 150: permanent lubrication, from PN 25/ ANSI 300 pushbutton pump; DN 200: pushbutton pump; from DN 250: lever pump).

Lubrication must be performed in compliance with the operating instructions (see also the lubrication instruction plate of the gas meter). If clean gas is used, lubrication is to be performed at 3-month intervals, whereas lubrication must be performed more frequently if dust- and/or condensate-laden gas is used.

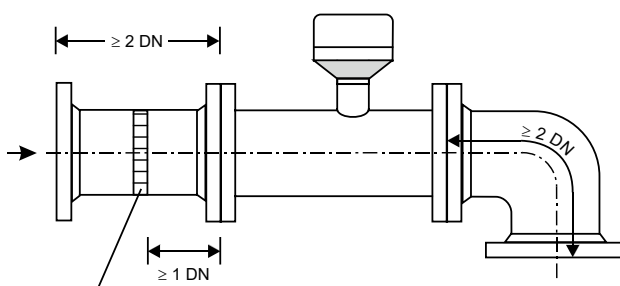

Perforated-plate straightener

TURBINE METER TRZ 03

Pulse outputs, Dimensions, Weights

Pulse outputs

The meter head is fitted with a reed contact as LF pulse transmitter as standard feature. But optionally, another two sensors can be fitted, e.g. another LF pulse transmitter (inductive sensor with output pulses complying with NAMUR or reed contact) and an HF1 pulse transmitter (NAMUR).

Connection is made by means of a 7-pin Binder plug:

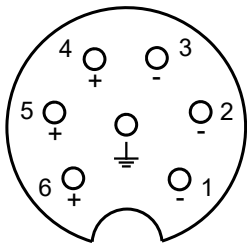

- 1, 4: LF (reed contact)
- 2, 5: LF or HF 1-signal
- 3, 6: HF1 (NAMUR)

If only one LF pulse transmitter is fitted, it is always connected to the contacts 1 and 4; a single HF1 pulse transmitter is always connected to the contacts 3 and 6. If high-frequency pulse transmitters (with output pulses complying with NAMUR) are fitted which scan either the turbine wheel (HF3) or the reference wheel (HF2), each

of them is connected separately using a Binder plug at the front of the device:

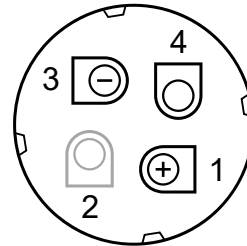

- 1, 3: HF2 or HF3-signal

The contacts 2 and 4 are not assigned.

All pulse transmitters are intrinsically safe and may be connected only to certified intrinsically safe circuits for use in areas subject to explosion hazards.

Maximum pulse transmitter frequencies:

- LF: 0.3 Hz
- HF1: 300 Hz
- HF2: 2.1 kHz
- HF3: 2.1 kHz

The phase displacement between the signals from the HF2 and HF3 pulse transmitters is 180°.

Dimensions, weights

DN mm / inch	Approx. weight (kg) pressure rating									Dimensions mm			
	PN						ANSI			H	C	L	B
	10	16	25	40	64	100	150	300	600				
50 / 2"	13	13	21	21	21	21	13	13	21 ¹⁾	210	60	150	160
80 / 3"	20	20	25	25	34	34	20	25	36	230	96	240	180
100 / 4"	25	25	32	32	45	45	30	35	55	270	120	300	200
150 / 6"	50	50	60	60	70	90	50	65	100	285	180	450	220
200 / 8"	75	75	95	95	150	160	100	120	160	320	240	600	260
250 / 10"	100	110	135	150	180	225	110	160	260	330	300	750	390
300 / 12"	138	150	225	265	275	290	155	230	310	360	360	900	410
400 / 16"	280	290	350	440	525	580	350	460	575	400	480	1200	450
500 / 20"	560	610	640	700	830	1060	620	650	1075	450	600	1500	490
600 / 24"	900	940	980	1075	1230	1570	950	1000	1600	500	720	1800	540

¹⁾ Monoflange design

From DN 80 to DN 300, the turbine meters with a pressure rating of PN 10/16 can be fitted with a thermo-well to accommodate a temperature sensor.

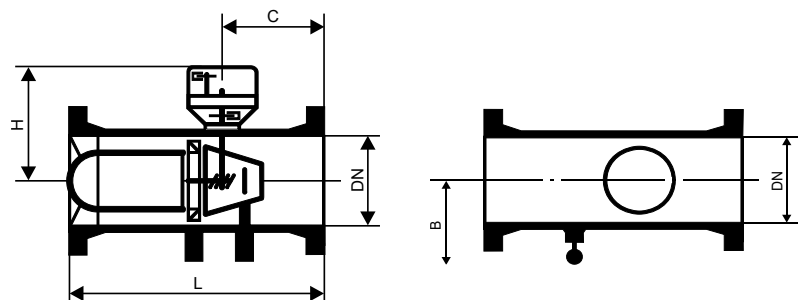

Measuring ranges

DN mm	Sizes	Q _{max} (m ³ /h)	Q _{min} (m ³ /h)	Q _t (m ³ /h)	Q _{min} , depending on minimum operating pressure p _{min} (m ³ /h)													
					1:20		1:30		1:50		1:80		1:100		1:120		1:160	
					Q _{min}	p _{min}	Q _{min}	p _{min}	Q _{min}	p _{min}	Q _{min}	p _{min}	Q _{min}	p _{min}	Q _{min}	p _{min}	Q _{min}	p _{min}
50	G 65	100	5 ²⁾	20	5 ¹⁾	3												
80	G 100	160	8 ²⁾	32	5	15	3.2	50										
	G 160	250	12.5	50	8	3	5	10	3.2	50								
	G 250	400	20	80	13	3	8	10	5	25								
100	G 160	250	12.5	50	8	3	5	25										
	G 250	400	20	80	13	3	8	10	5	25								
	G 400	650	32	130	20	3	13	4	8	10	6.5	15	5	25				
150	G 400	650	32	130	20	3	13	10	8	25	6.5	40						
	G 650	1000	50	200	32	3	20	4	13	10	10	15	8	25				
	G 1000	1600	80	320	50	3	32	4	20	10	16	15	13	25	10	40		
200	G 1000	1600	80	320	50	3	32	4	20	10	16	15	13	25	10	40		
	G 1600	2500	125	500	80	3	50	4	32	10	25	15	20	25	16	40		
250	G 1000	1600	80	320	50	3	32	10	20	25	16	40						
	G 1600	2500	125	500	80	3	50	4	32	10	25	25	20	40	16	60		
	G 2500	4000	200	800	130	3	80	4	50	10	40	25	35	40	25	60		
300	G 2500	4000	200	800	130	3	80	4	50	10	40	25	35	40	25	60		
	G 4000	6500	320	1300	220	3	130	10	80	25	65	40	55	40	40	80		
	G 4000-45	6500	320	1300	220	3	130	10	80	25	65	40	55	60	40	80		
400	G 4000	6500	320	1300	220	3	130	10	80	25	65	40	55	60	40	80		
	G 6500	10000	500	2000	335	3	200	10	125	25	100	40	85	60	63	80		
	G 6500-45	10000	500	2000	335	3	200	10	125	25	100	40	85	60	63	80		
500	G 6500	10000	500	2000	335	3	200	10	125	25	100	40	85	60	63	80		
	G 10000	16000	800	3200	535	3	320	10	200	25	160	40	135	60	100	80		
600	G 10000	16000	800	3200	535	3	320	10	200	25	160	40	135	60	100	80		
	G 16000	25000	1250	5000	835	3	500	10	315	25	250	40	210	60	160	80		

1) Measuring range 1:20 2) with p_{min} = 3 bar

Order information

- Nominal size of the pipeline
- Size G
- Operating pressure (min/max) in bar g or bar a
- Operating temperature (min/max)
- Ambient temperature (min/max)
- Type of gas to be used
- Pressure rating and DIN or ANSI flange design
- Direction of flow / mounting position
- Accessories: inlet section, volume corrector, etc.
- Options: HF pulse outputs, etc.
- Special designs, e.g. for aggressive gases

For More Information

To learn more about RMG's advanced gas solutions, contact your RMG account manager or visit www.rmg.com

RMG Messtechnik GmbH

Otto-Hahn-Strasse 5
35510 Butzbach, Germany
Tel: +49 (0)6033 897-0
Fax: +49 (0)6033 897-130

TRZ 03
2019-01
© 2019 RMG Messtechnik GmbH

